

Paper Plate Rocket Craft

Rocket Strips - Color or print on favorite colored paper

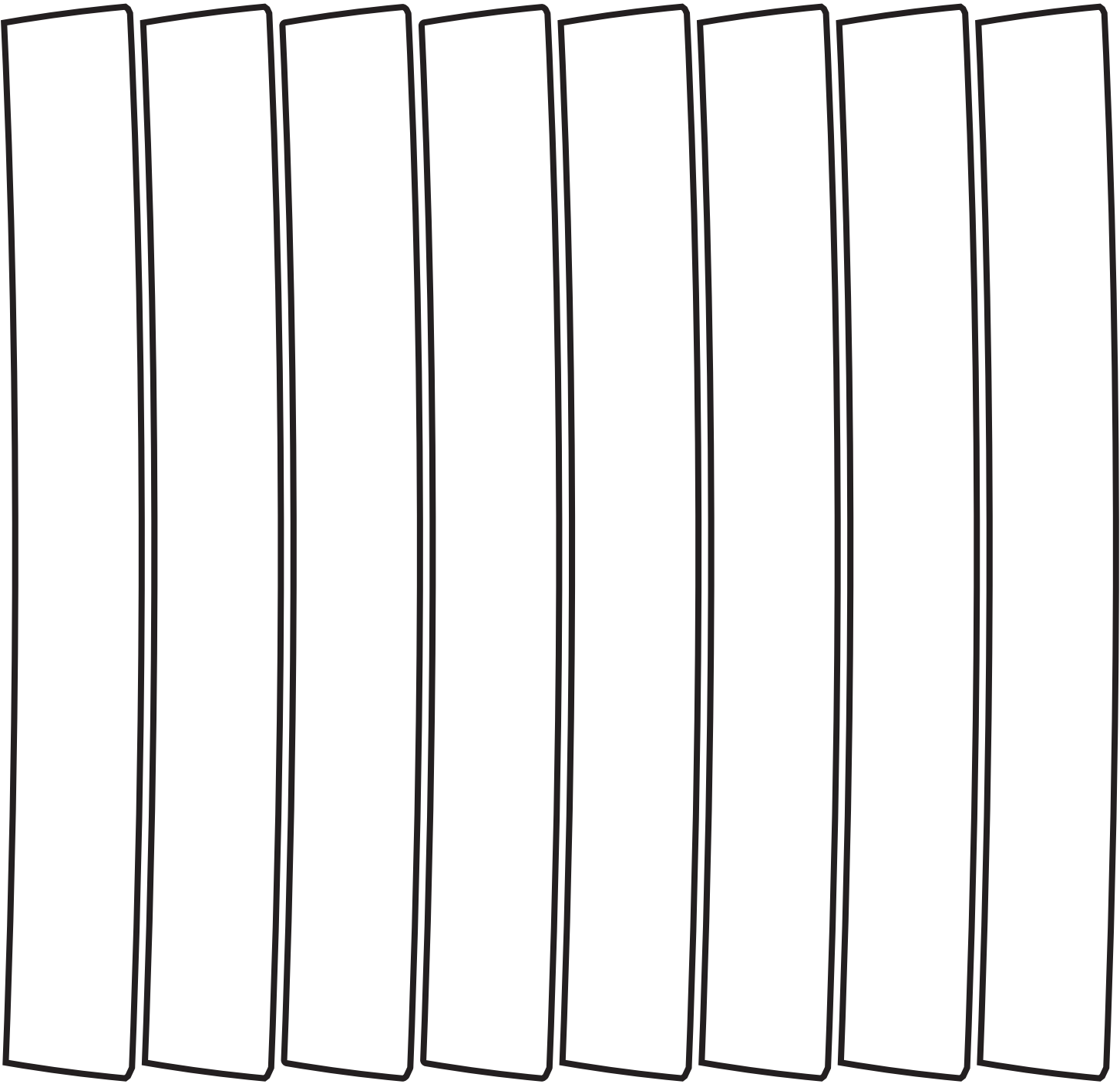

Paper Plate Rocket Craft

Window

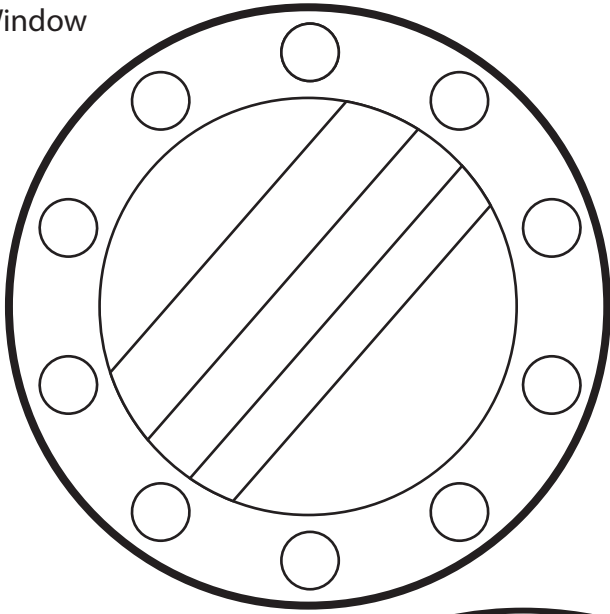

Fins

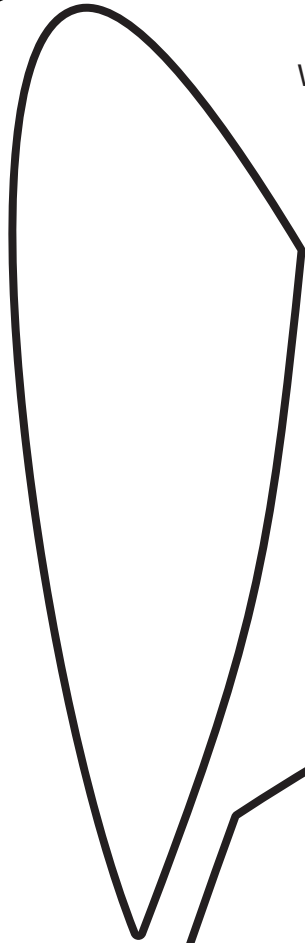

Engine



Exhaust
Flame

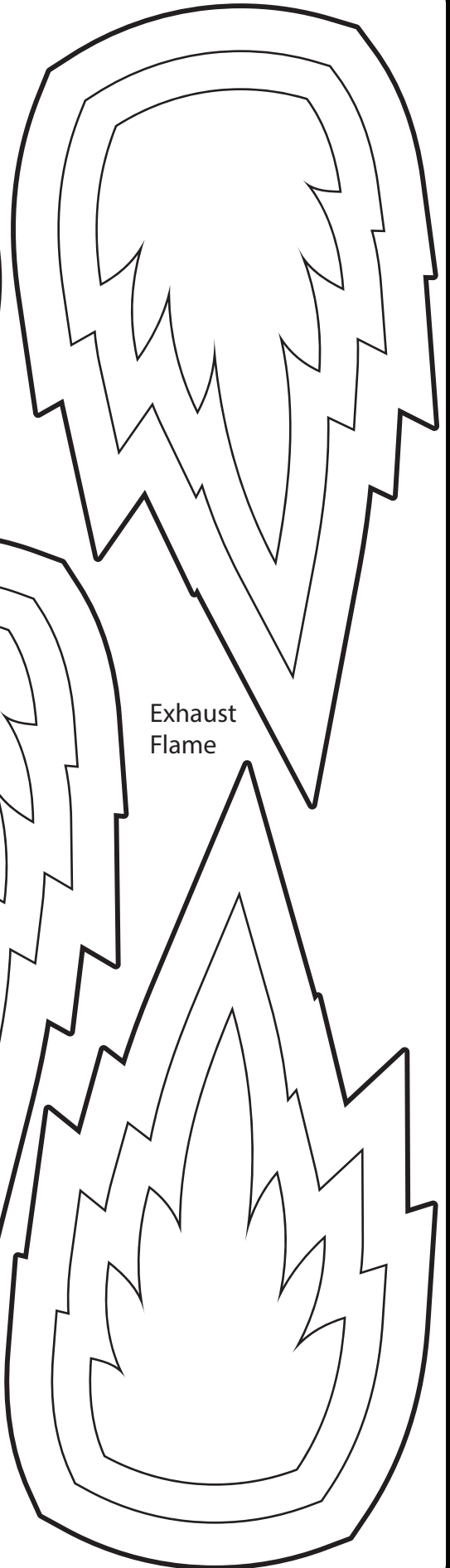

Paper Plate Rocket Craft



Fins

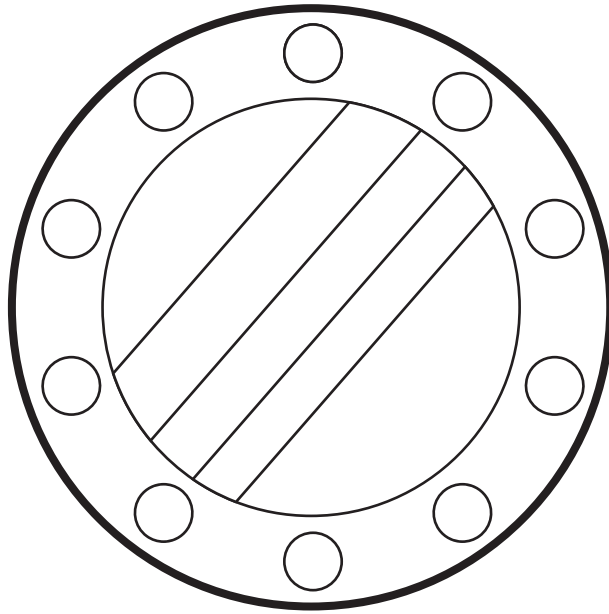

Window

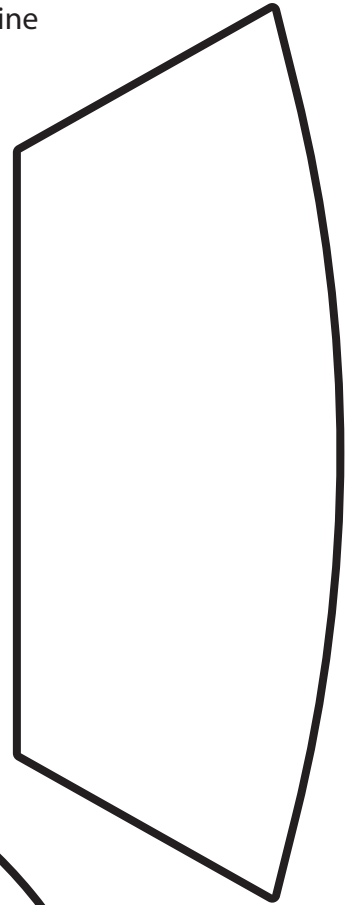

Engine

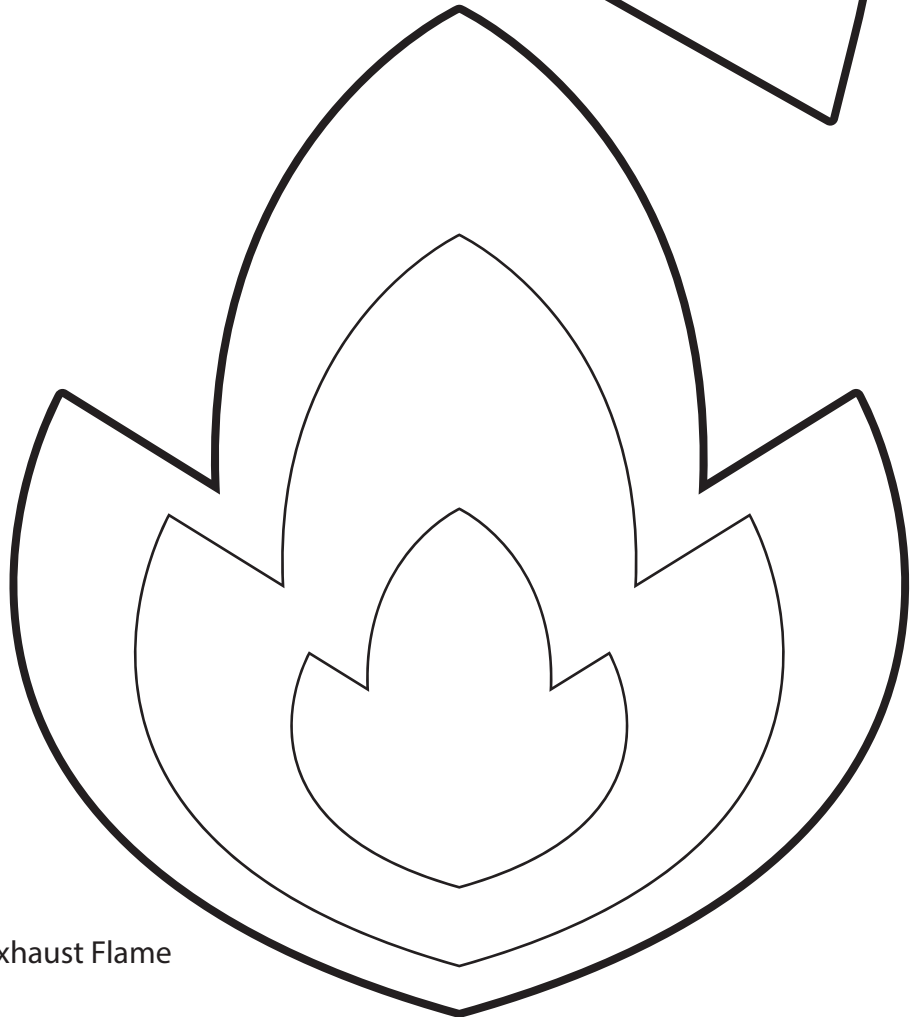

Exhaust Flame

Paper Plate Rocket Craft

Engine

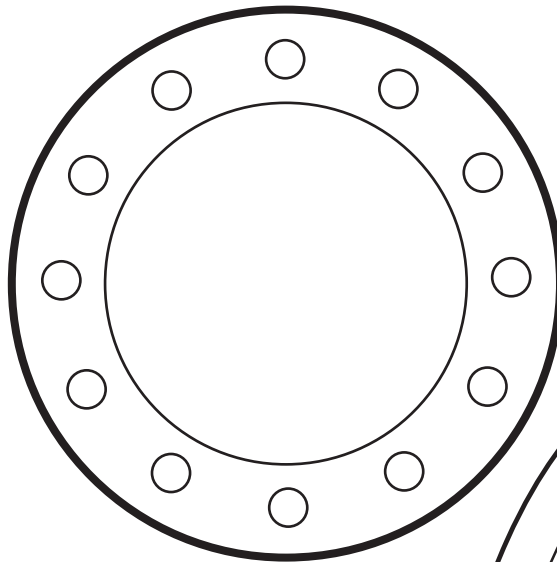
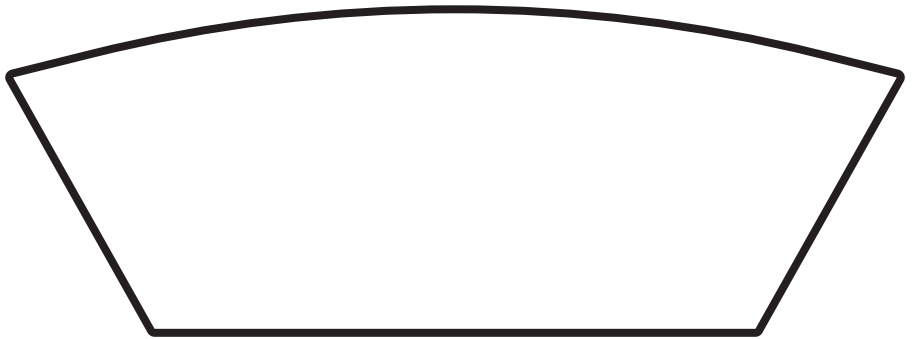

Window

Exhaust Flame

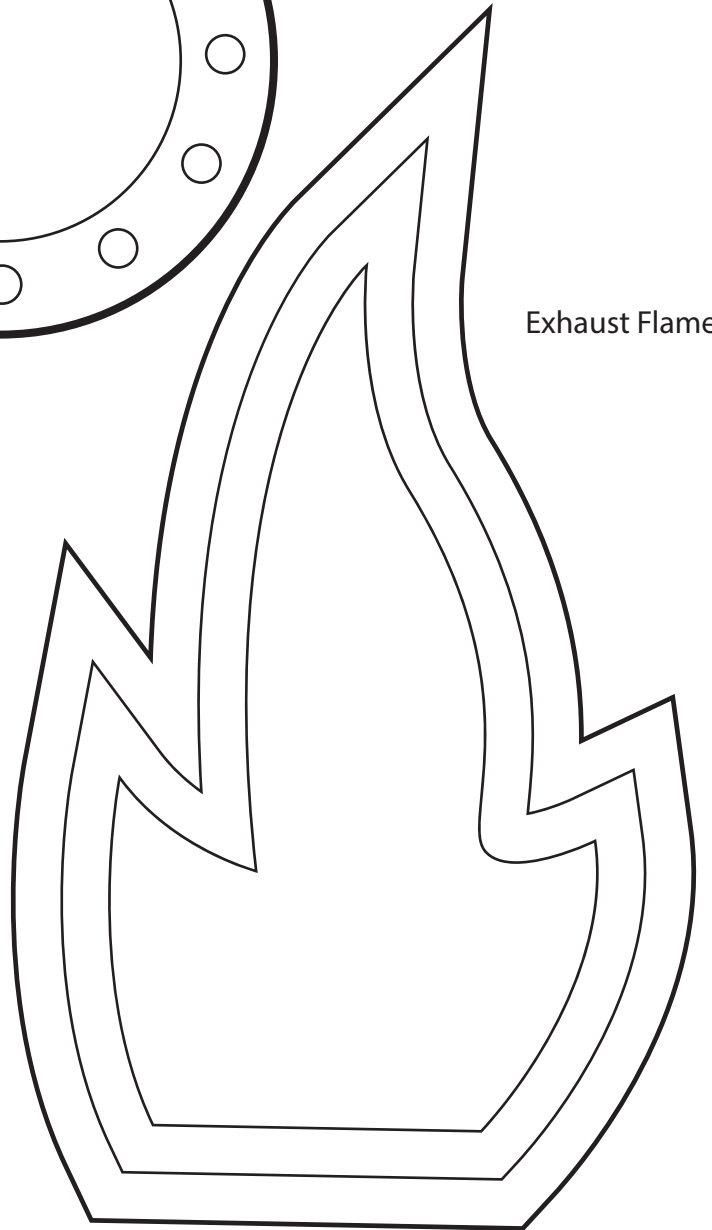

Fins



Paper Plate Rocket Craft

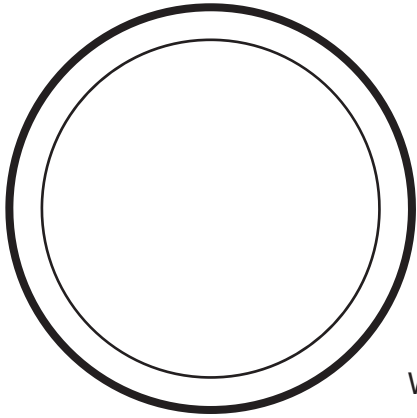

Window

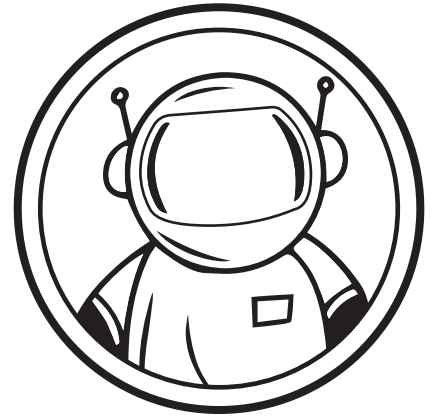
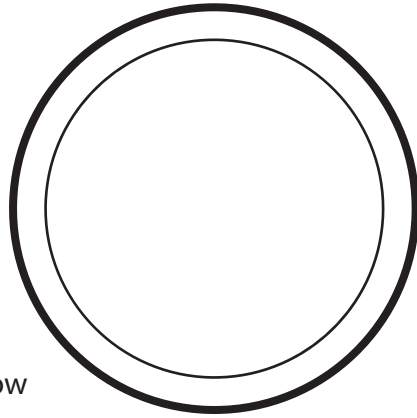

Engine

Exhaust Flame

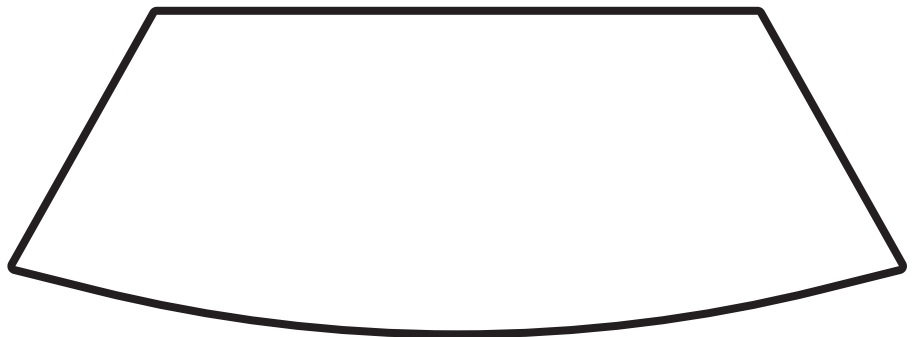
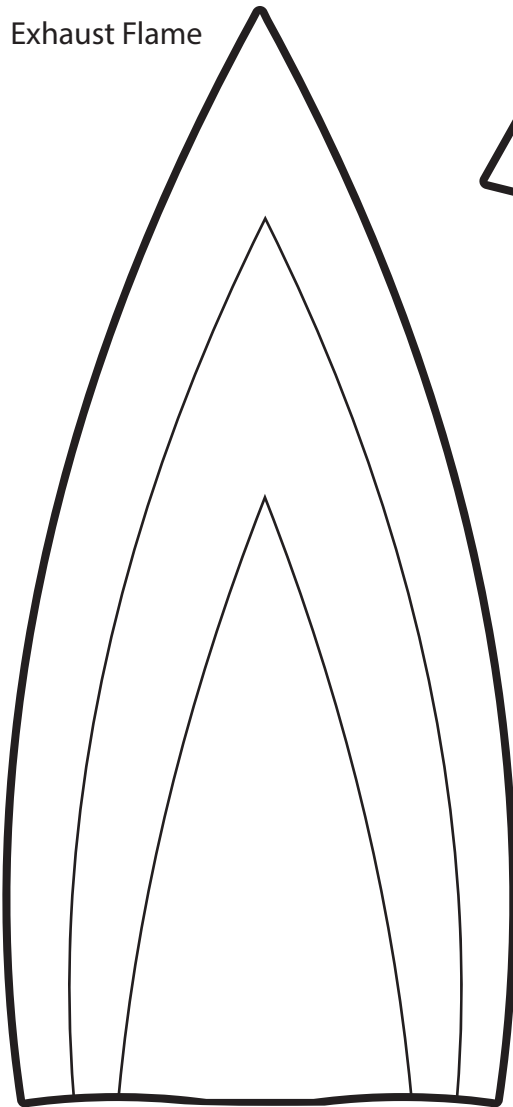

Fins

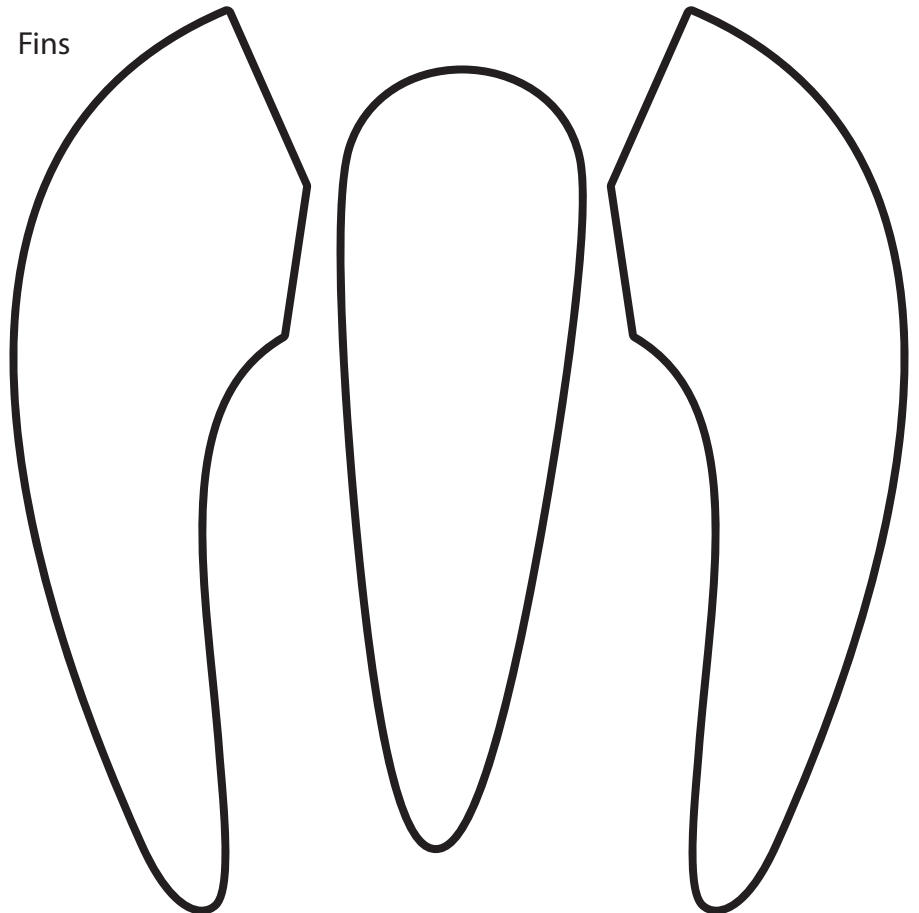

Paper Plate Rocket Craft

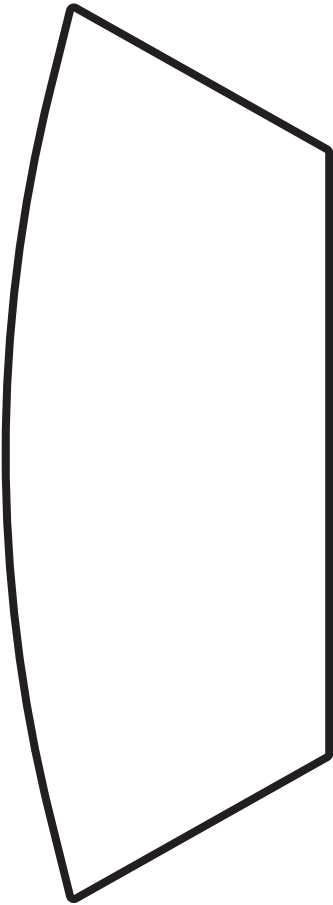

Exhaust Flame

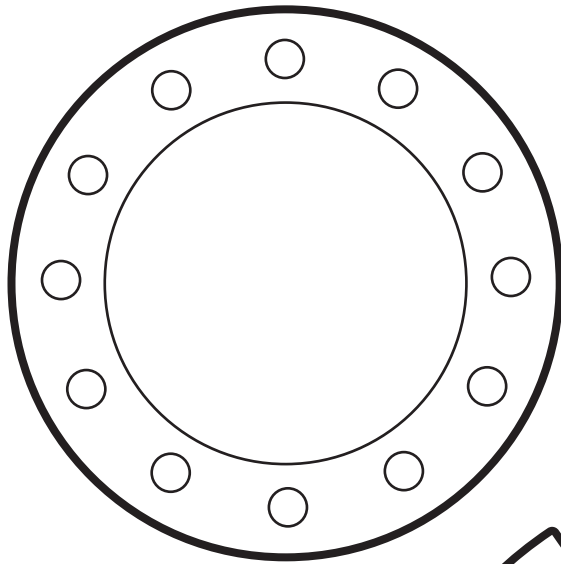

Engine

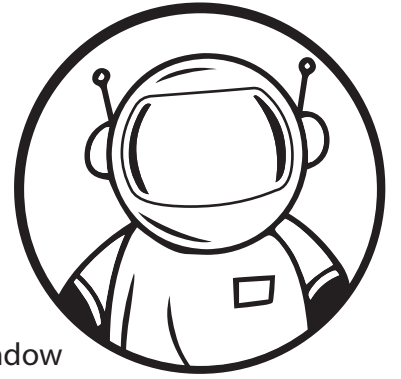

Window



Fins

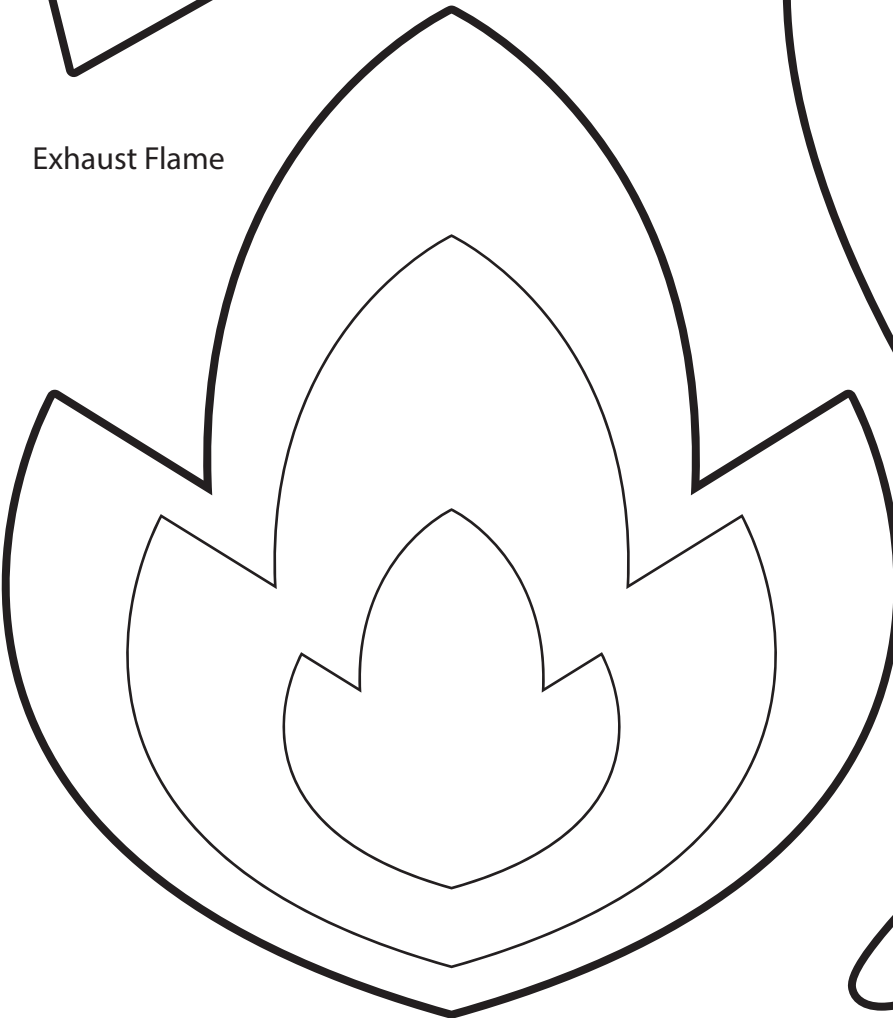

Paper Plate Rocket Craft

Exhaust Flame

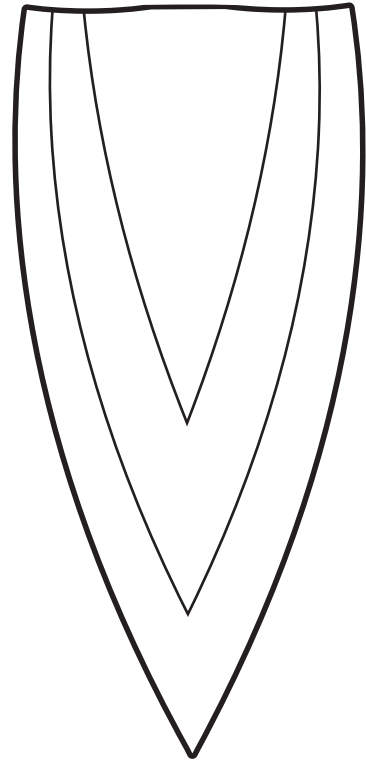

Fins

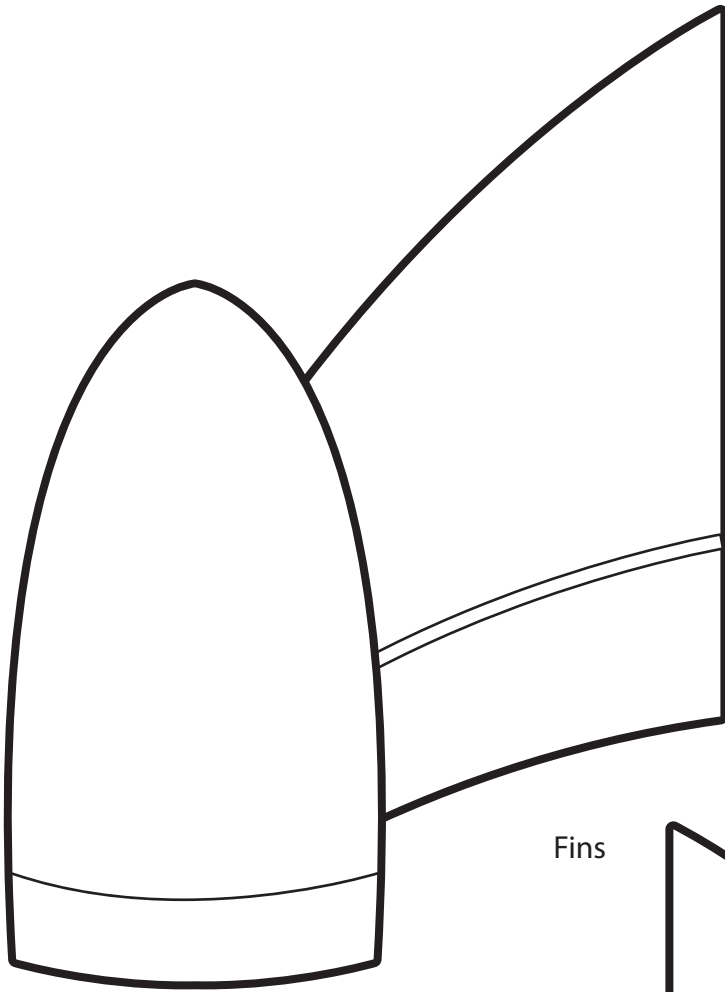

Exhaust Flame

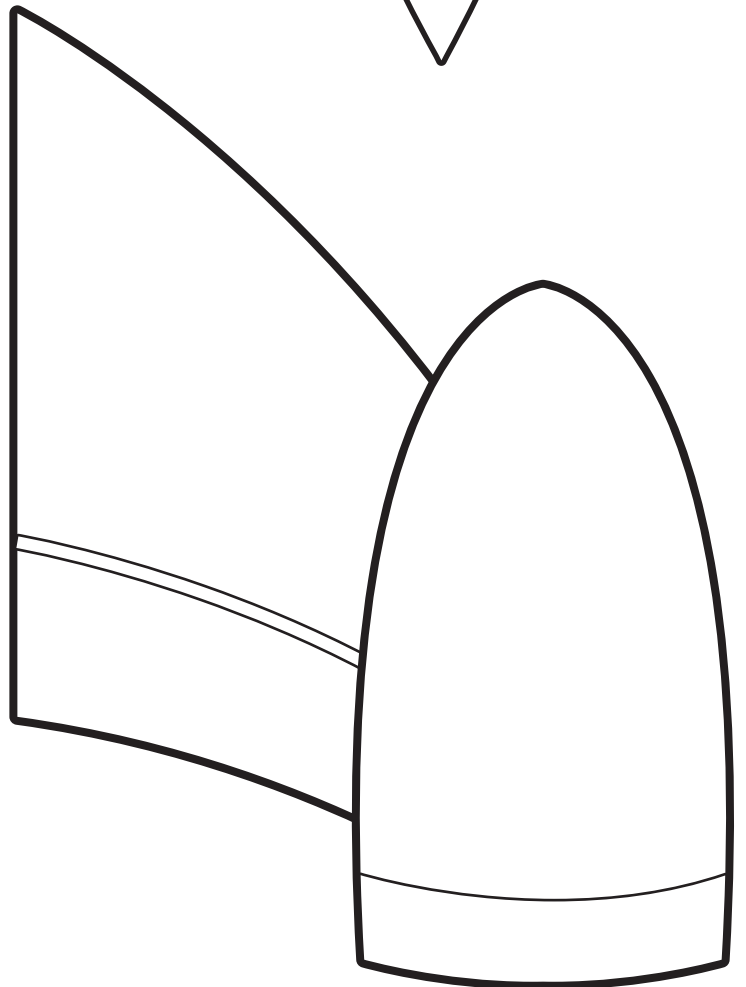
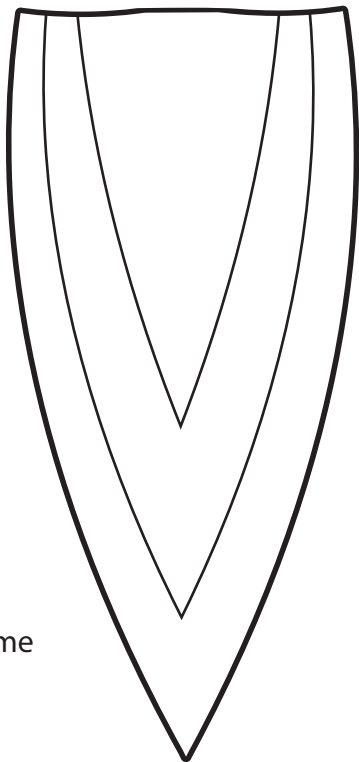

Paper Plate Rocket Craft

Exhaust Flame

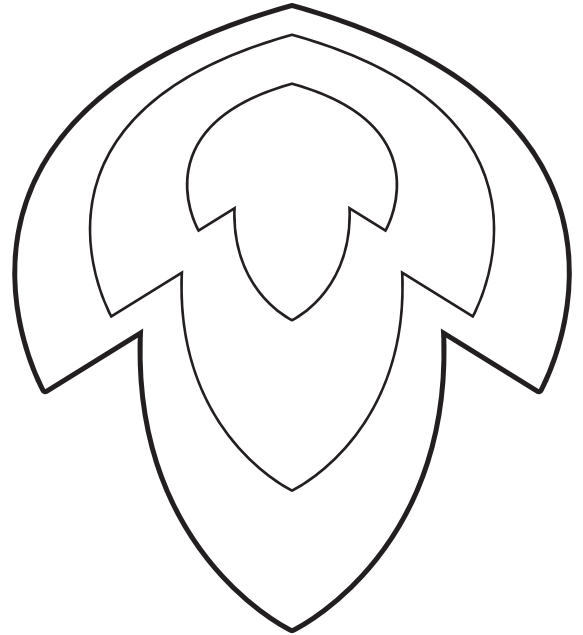

Fins

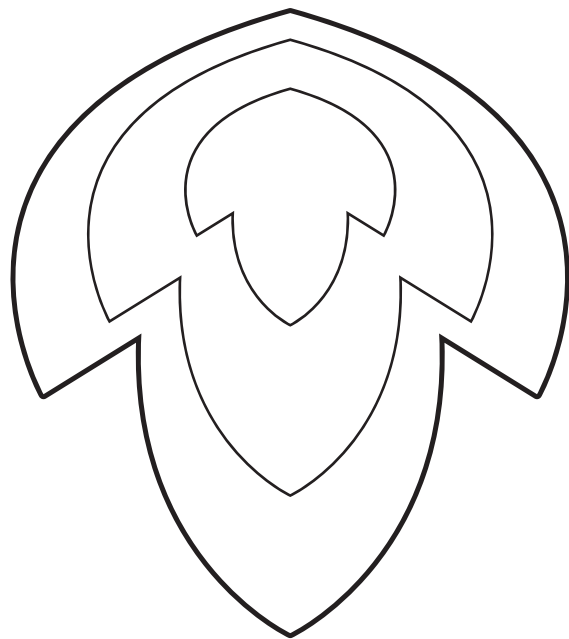
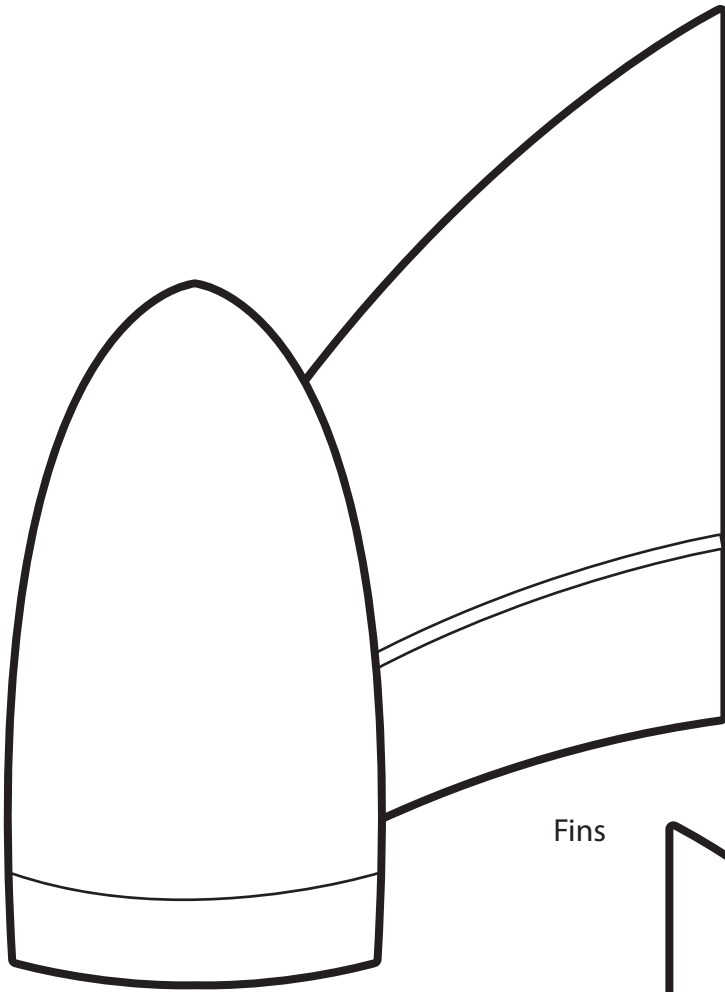

Exhaust Flame

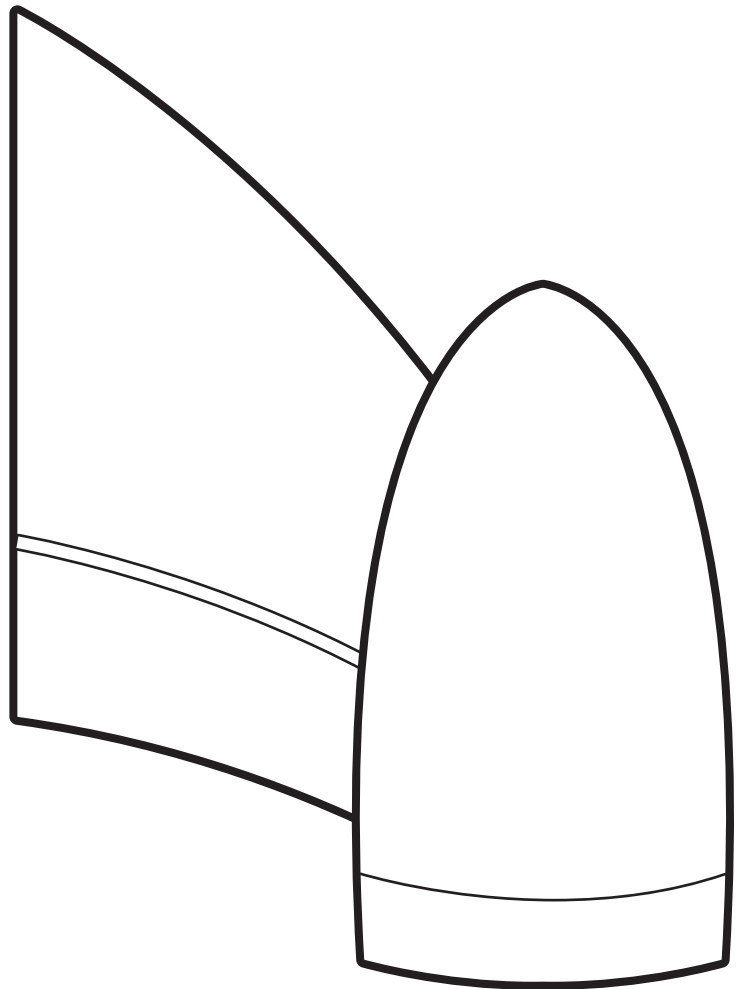

Paper Plate Rocket Craft

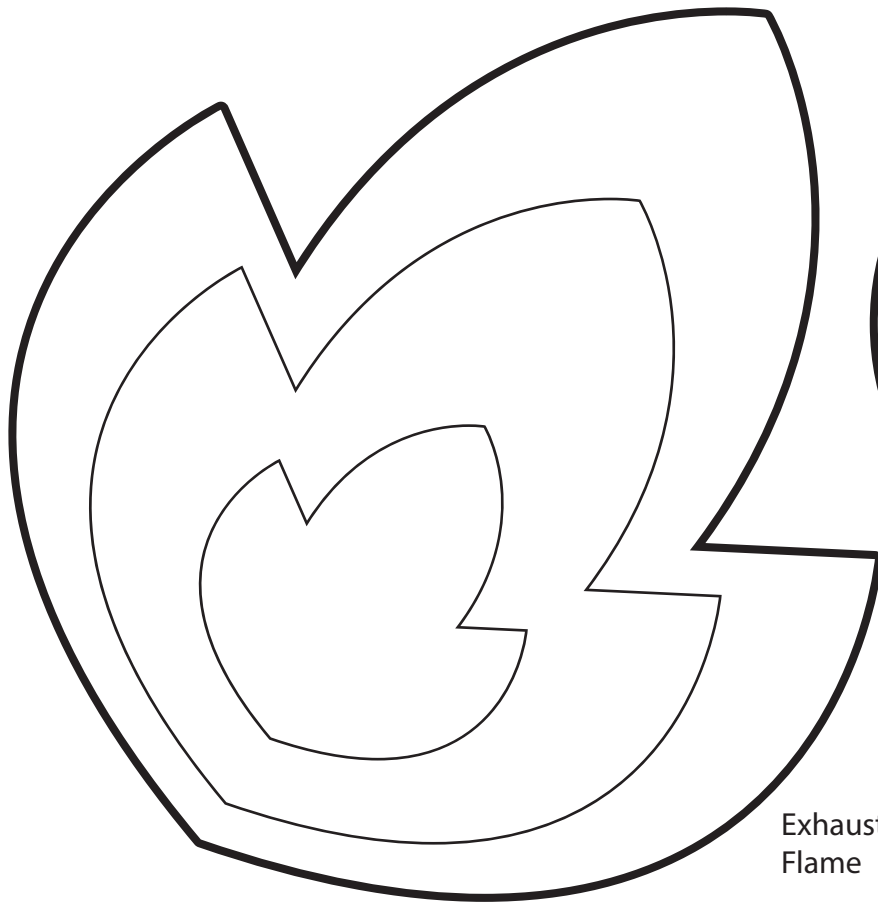

Exhaust
Flame

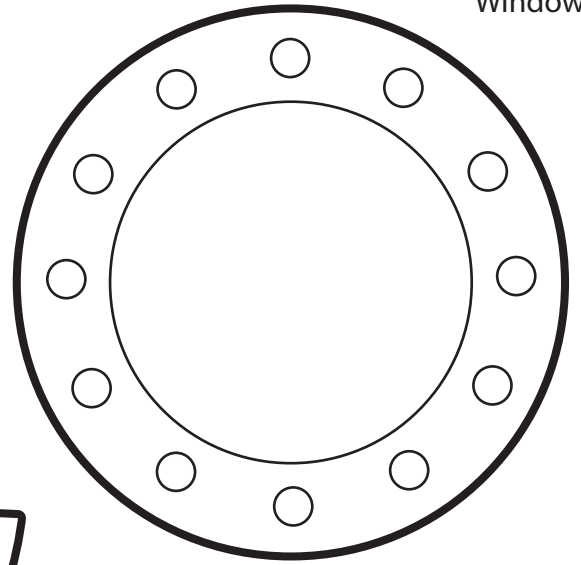

Window

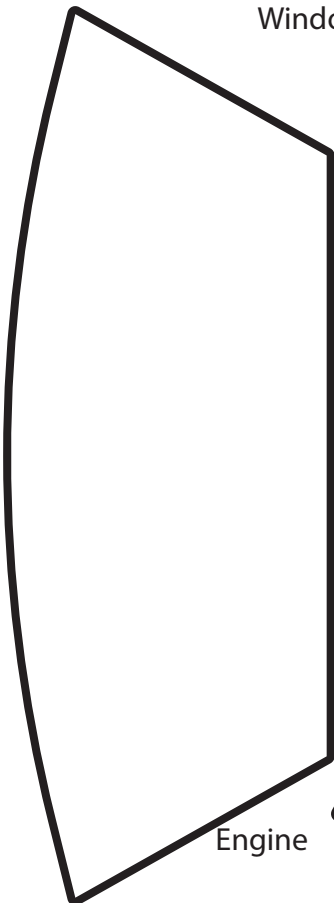

Engine

Window

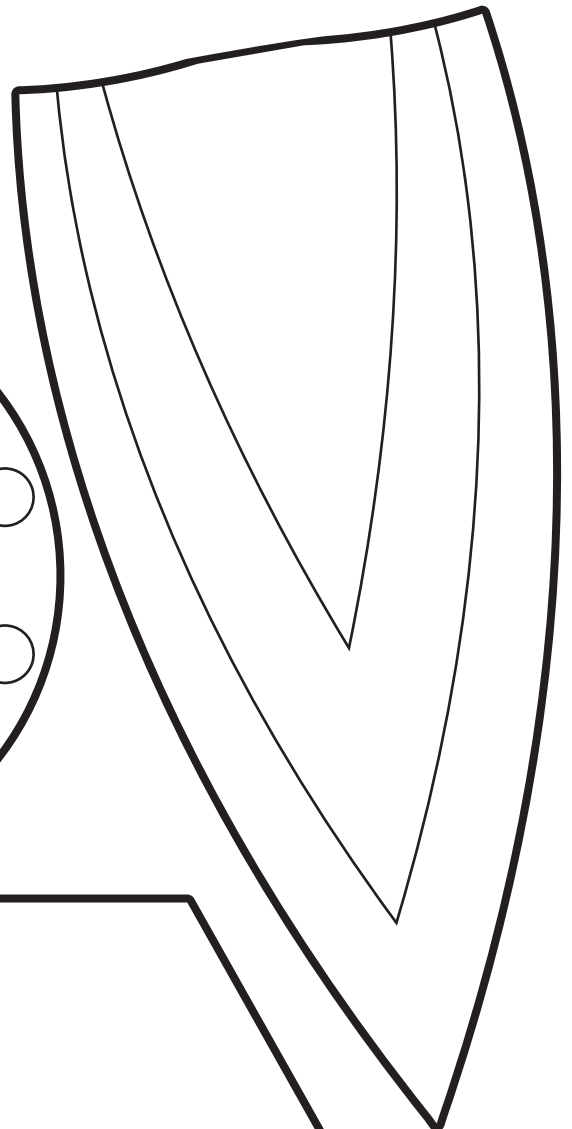
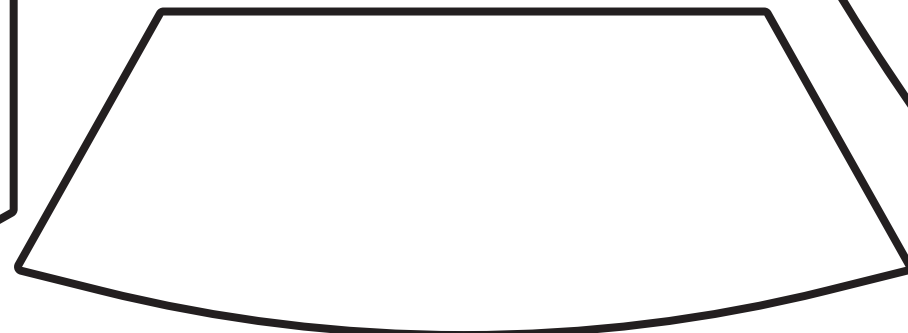
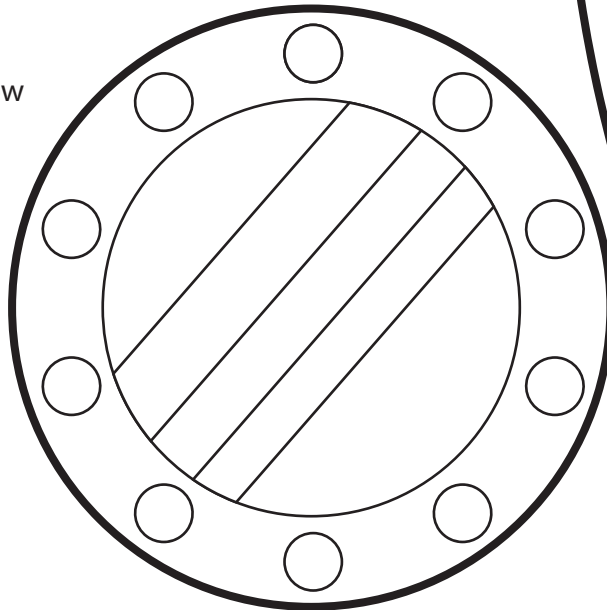

Paper Plate Rocket Craft

Assemble Ideas! - Choose your favorite rocker and print the pages under it.

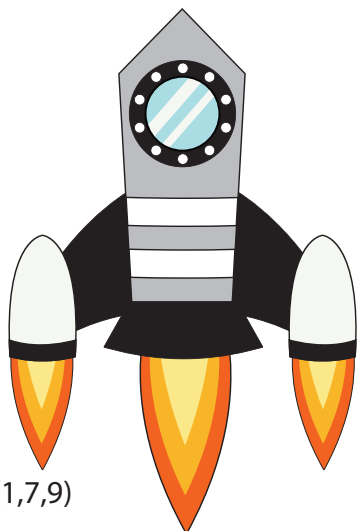

(1,7,9)

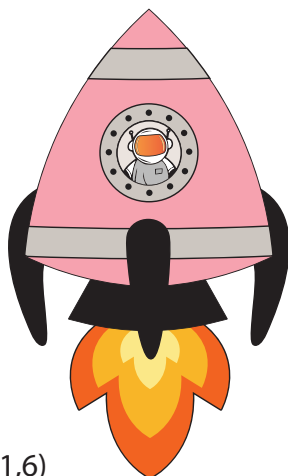

(1,6)

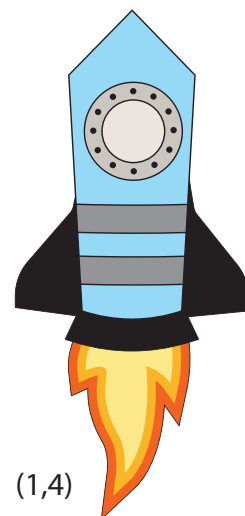

(1,4)

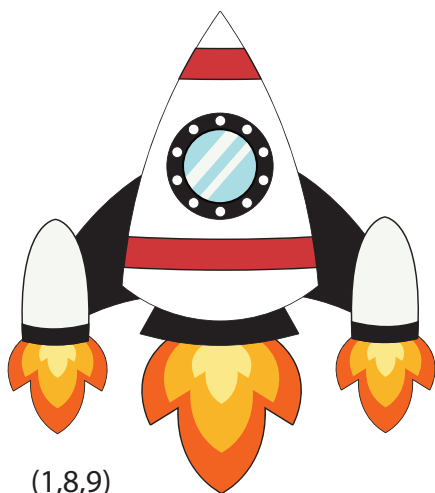

(1,8,9)

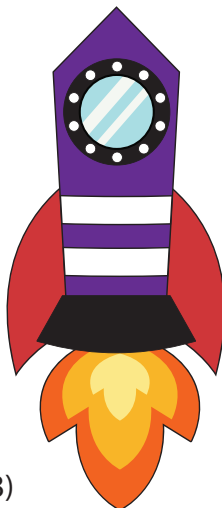

(1,3)

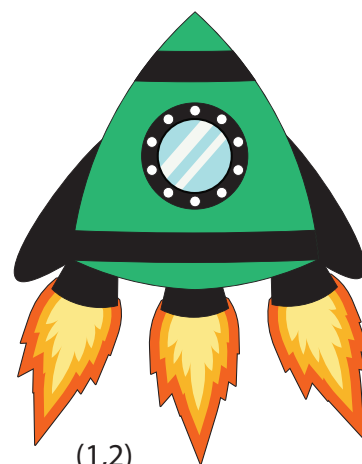

(1,2)

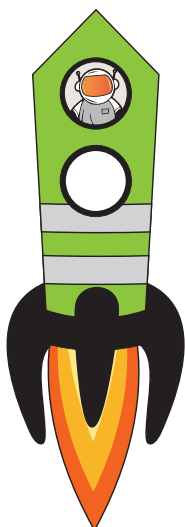

(1,5)

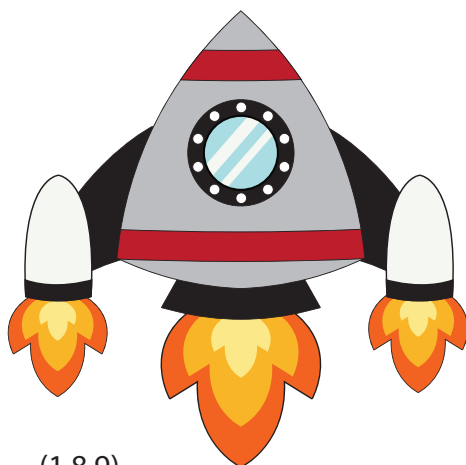

(1,8,9)

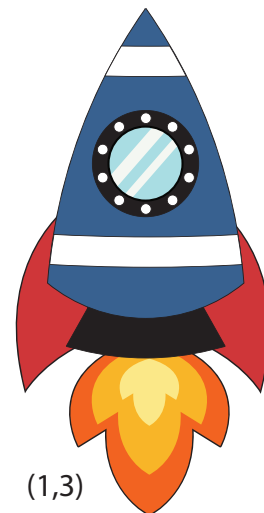

(1,3)

Paper Plate Rocket Craft

1. Fold paper plate in half

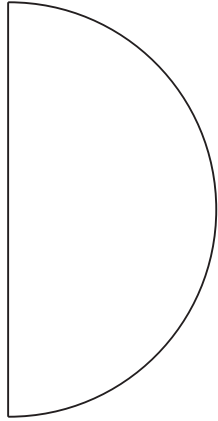

2. Trace and cut through lines

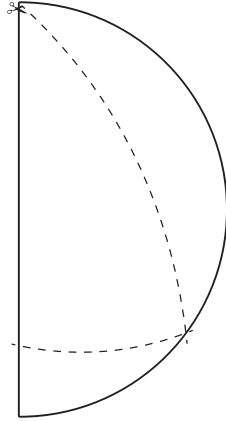

3. Open Paper plate

